



Bloque de distribución 250A, UKK250A



5012.009



Características



Bloque de distribución modular, monopolar, cable y busbar, 250A 600V, entrada 1x 250-6 AWG, salida 2x 1-14AWG/5x 14-4AWG/4x 6-14 AWG

- Dimensiones: 96 mm (alto), 49 mm (ancho), 50 mm (profundidad)
- Voltaje de operación: 690 V (IEC), 600 V (UL)
- Corriente de operación: 250 A (IEC60947-7-1), 255 A (UL/CSA)









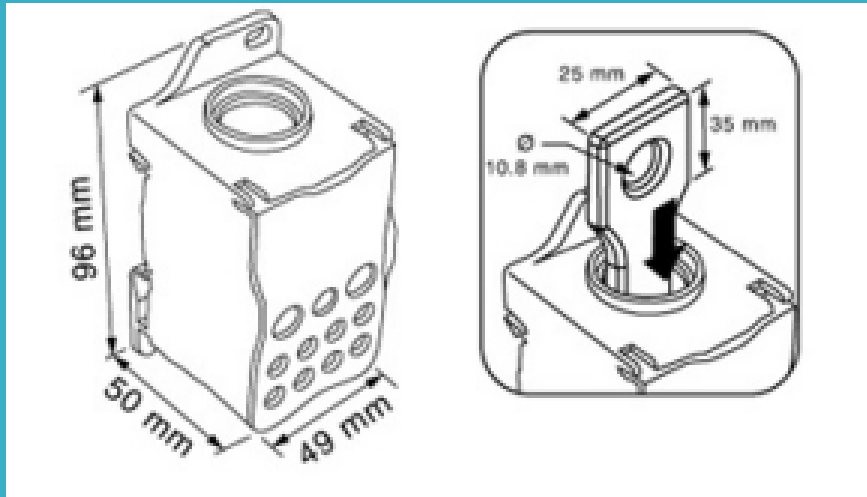

Cables entrada  / salida 











Contáctanos

-  (55)79477137
-  cotizaciones@spsinergia.com
-  Maria Luisa Martínez 139,
Morelia Michoacán. CP 58150



Metric system	 mm ²	 mm ²		Γ (N.m)
	35...120		x1	 16
	6...35	6...25	x2	 4.0
	2.5...16	2.5...16	x5	 2.7
	2.5...10	2.5...10	x4	 2.5

U.S. Regulations	AMG			Torque
	6...250 Kcmil	x1		201
	14...1	x2		35
	14...4	x5		24
	14...6	x4		17.5



C E R T I F I C A T E

ATTESTATION CERTIFICATE OF ELECTROMAGNETIC COMPATIBILITY AND LOW VOLTAGE DIRECTIVES

Technical file of the company mentioned below has been observed and audit has been completed successfully.

2014/30/EU Electromagnetic Compatibility Directive and
2014/35/EU Low Voltage Directives have been taken as references for these processes

Company Name : **Shanghai Leipold Electric Co., Ltd.**

Company Address : No.1569 Siyi Road, Jiading, Shanghai, China

Related Directives and Annex : **2014/35/EU Low Voltage Directive**
2014/30/EU Electromagnetic Compatibility Directive

Related Standards : **EN 60947-1:2007/A2:2014;EN 60947-7-1:2009**

Product Name : **Power Distribution Blocks**

Report No and Date : KOSE2018052932;26.05.2018

Product Brand/Model/Type : UK207,UK407,UK411,UK412,UK415,UKK-80A,
UKK-125A,UKK-160A,UKK-250A,UKK-400A,UKK-500A,
UKK600A,JUKH125,JUKH250,UKK6/47,UKK6/47LE,
UKK6G/158,UKK6G-100,UKK6G-250,UKK6G-400,UKK6G-600,
UKK6N-100,UKK6N-250,UKK6N-400,UKK6N-600,UKK6NB-100,
UKK6NB-250,UKK6NB-400,UKK6NB-600

Certificate Number : **M.2018.201.N5030**

Initial Assessment Date : 14.06.2018

Registration Date : 15.06.2018

Reissue Date/No : -

Expiry Date : 14.06.2023

The validity of the certificate can be checked through www.udem.com.tr. The CE mark shown on the right can only be used under the responsibility of the manufacturer with the completion of EC Declaration of Conformity for all the relevant Directives. This certificate remains the property of UDEM International Certification Auditing Training Centre Industry and Trade Inc. Co. to whom it must be returned upon request. The above named firm must keep a copy of this certificate for 15 years from the registration of certificate. This certificate only covers the product(s) stated above and UDEM must be noticed in case of any changes on the product(s)

Address: Mutlukent Mahallesi 2073 Sokak (Eski 93 Sokak) No:10 Çankaya – Ankara – TURKEY

Phone: +90 0312 443 03 90 **Fax:** +90 0312 443 03 76

E-mail: info@udemltd.com.tr www.udem.com.tr

UDEM International Certification
Auditing Training Centre Industry
and Trade Inc. Co.

